

Slit Lamp Adapters and Workstations Operator Manual



Slit Lamp Adapters and Workstations Operator Manual
15505-EN Rev D 2019 06

© 2019 by IRIDEX Corporation. All rights reserved.

IRIDEX, the IRIDEX logo, IRIS Medical, OcuLight, EndoProbe, and SmartKey are registered trademarks; BriteLight, CW-Pulse, DioPexy, EasyFit, EasyView, FiberCheck, G-Probe, IQ 532, IQ 577, IQ 810, LongPulse, MicroPulse, MilliPulse, OtoProbe, PowerStep, Symphony, TruFocus, and TruView are trademarks of IRIDEX Corporation. All other trademarks are the property of their respective holders.

1	Introduction	1
	SLAs.....	1
	Indications for Use.....	1
	Recommended Procedures.....	1
	Warnings and Cautions	2
	IRIDEX Corporation Contact Information.....	3
2	Operation	4
	About the Components.....	4
	Connecting Consoles.....	7
	Install SLA on a Slit Lamp.....	8
	Install Interface Box (SL 130 Integrated Workstation).....	12
	Treating Patients	13
3	Troubleshooting	14
	General Problems.....	14
4	Maintenance	16
	Inspecting the SLA.....	16
	Cleaning the Fiber-Optic Connector	16
	Cleaning the External Surfaces	16
	Cleaning the Delivery Mirror and Eye Safety Filter	17
	Replacing the Slit Lamp Illumination Lamp	17
5	Safety and Compliance	18
	Protection for the Physician	18
	Protection for All Treatment Room Personnel.....	18
	Safety Compliance	19
	Labels.....	19
	Symbols (As Applicable)	21
	SLA Specifications	22

1

Introduction

Slit lamp adapters (SLA) connect a laser console to a diagnostic slit lamp, enabling diagnostic evaluation and transpupillary laser photocoagulation to be conducted at the same workstation.

SLAs feature parfocal adjustment of all spot sizes for precise focus and consistent burns, a transparent, integral eye safety filter (ESF), and on some models, a micromanipulator.

This manual provides documentation for the following SLAs and slit lamp workstations.

SLAs

SLA	Distinguishing Features
Standard SLA	Standard and large spot beam delivery
EasyFit™	Compatible with Zeiss-style slit lamp or the Zeiss Integrated SL Workstation
FiberCheck™	Verifies fiber integrity at the distal end of the fiber cable
Symphony™ / Symphony 2	Multi-wavelength SLA to connect to 2 IRIDEX laser systems
EasyView™	Can rotate out of position for use with Haag-Streit-style slit lamps.

Workstations

Workstation	Distinguishing Features
Integrated IRIDEX Workstation	Includes IRIDEX EasyFit SLA

Indications for Use

SLAs and workstations, when connected to an IRIDEX laser, are indicated for retinal photocoagulation, laser trabeculoplasty, and peripheral iridotomy.

Recommended Procedures

POWER DENSITY AND SPOT SIZE

Tissue response to laser light is primarily determined by power density. Power density is laser power divided by the area of the spot. To increase power density, increase the laser power or decrease the spot size.

POWER AND DURATION

If uncertain of tissue response, start with the lower power settings and increase the power until satisfactory clinical lesions are observed.

Shorter pulse durations may require higher power settings to create a burn.

RED AIMING AND TREATMENT BEAMS

Ensure that the aiming beam is always in sharp focus during laser delivery. An out-of-focus spot may not produce a clinically satisfactory lesion.

Warnings and Cautions



WARNINGS:

Lasers generate a highly concentrated beam of light that may cause injury if improperly used. To protect the patient and the operating personnel, the entire laser and the appropriate delivery system operator manuals should be carefully read and comprehended before operation.

Never look directly into the aiming or treatment beam apertures or the fiber-optic cables that deliver the laser beams, with or without laser safety eyewear.

Never look directly into the laser light source or at laser light scattered from bright reflective surfaces. Avoid directing the treatment beam at highly reflective surfaces such as metal instruments.

Ensure that all personnel in the treatment room are wearing the appropriate laser safety eyewear. Never substitute prescription eyewear for laser safety eyewear.

Always keep the IRIDEX laser in Standby mode when you are not treating a patient. Maintaining the IRIDEX laser in Standby mode prevents accidental laser exposure if the footswitch is inadvertently pressed.

If you are using a beam splitter, you must install the fixed ESF for the appropriate wavelength before installing the beam splitter.

The relationship between spot size and resultant power density is not linear. Halving the spot size quadruples the power density. The physician must understand the relationship among spot size, laser power, power density, and laser/tissue interaction before using the SLA.

Always inspect the fiber-optic cable before connecting it to the laser to ensure that it has not been damaged. A damaged fiber-optic cable could cause accidental laser exposure or injury to yourself, your patient, or others in the treatment room.

Always verify that the delivery device is properly connected to the laser. An improper connection may result in an inadvertent secondary laser beam. Severe eye or tissue damage could occur.

Do not use the delivery device with any laser system other than an IRIDEX laser. Such use may void product warranties and jeopardize the safety of the patient, yourself, and others in the treatment room.

Tissue absorption is directly dependent upon presence of pigmentation; therefore, dark pigmented eyes will require lower energies to obtain equivalent results as compared to light pigmented eyes.

Observation equipment such as a beam splitter or co-observation tube must be installed between the ESF and the oculars.



CAUTIONS:

US federal law restricts this device to sale by or on the order of a healthcare practitioner licensed by the law of the State in which he/she practices to use or order the use of the device.

Use of controls or adjustments or performing of procedures other than those specified herein may result in hazardous radiation exposure.

Do not operate the equipment in the presence of flammables or explosives, such as volatile anesthetics, alcohol, and surgical preparation solutions.

Turn off the laser before inspecting any delivery device components.

Always handle the fiber-optic cables with extreme care. Do not coil the cable into a diameter less than 15 cm (6 in).

Keep the protective cap over the fiber-optic connector when the delivery device is not in use.

Do not touch the end of the fiber-optic connector, as finger oils can impair light transmission through the fiber-optic and reduce power.

Do not handle any illumination lamp by its glass bulb.

IRIDEX Corporation Contact Information



IRIDEX Corporation
1212 Terra Bella Avenue
Mountain View, California 94043-1824 USA

Telephone: (650) 940-4700
(800) 388-4747 (US only)
Fax: (650) 962-0486
Technical Support: (650) 962-8100
techsupport@iridex.com



Emergo Europe
Prinsessegracht 20
2514 AP The Hague
The Netherlands



Warranty and Service. This device carries a standard factory warranty. This warranty is void if service is attempted by anyone other than certified IRIDEX service personnel.

NOTE: *This Warranty and Service statement is subject to the Disclaimer of Warranties, Limitation of Remedy, and Limitation of Liability contained in IRIDEX's Terms and Conditions.*

Should you require assistance, please contact your local IRIDEX Technical Support representative or our corporate headquarters.



WEEE Guidance. Contact IRIDEX or your distributor for disposal information.

2 Operation

About the Components

After unpacking the contents of your SLA or workstation, ensure that you have all of the components ordered. Check the components carefully before use to ensure that no damage occurred during transit.

In addition to the SLA, you may have an ESF, a split-mirror illumination prism, a finger rest, a micromanipulator, mounting bracket, and installation tools, depending on the model.

Slit Lamp Compatibility

SLA Model*	Spot Size (µm)	Slit Lamp Model		Console Compatibility
		Haag-Streit	Zeiss	
Standard (50 µm)	50, 100, 200, 300, 500	✓	✓	GL / GLx / TX / IQ 532 / IQ 577
Large Spot (3 mm)	500, 800, 1200, 2000, 3000	✓	✓	SL / SLx
Large Spot (5 mm)	600, 1000, 1800, 3000, 5000	✓	✓	SLx / IQ 810
Symphony	50, 100, 200, 300, 500 (532 nm) 125, 200, 350, 600, 1000 (810 nm) 600, 1000, 1800, 3000, 5000 (810 nm)		✓	GL [‡] / GLx / TX / IQ 810 SLx / IQ 810 SLx / IQ 810
Symphony 2	50, 100, 200, 300, 500 (532 nm or 577 nm) 125, 200, 350, 600, 1000 (810 nm)		✓	GL [‡] / GLx / TX / IQ 532 / IQ 577 SLx / IQ 810
EasyFit	50, 100, 200, 300, 500		✓	GL [‡] / GLx / TX / IQ 532 / IQ 577
EasyView	50, 100, 200, 300, 500	✓		GL / GLx / TX / IQ 532 / IQ 577
FiberCheck (standard)	75, 125, 200, 300, 500 (810 nm)	✓	✓	IQ 810
FiberCheck (large spot)	600, 1000, 1800, 3000, 5000	✓	✓	IQ 810
IRIDEX Workstation	50, 100, 200, 300, 500	n/a	n/a	GL [‡] / GLx / TX / IQ 532 / IQ 577

* SLA models are console- and/or wavelength-specific and may not be used on a non-compatible system.
[‡] Serial Number > 41000

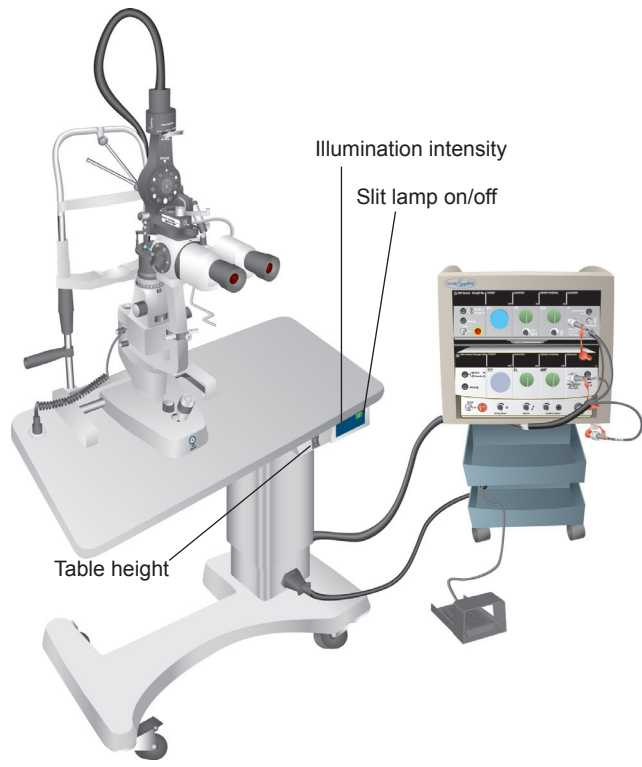
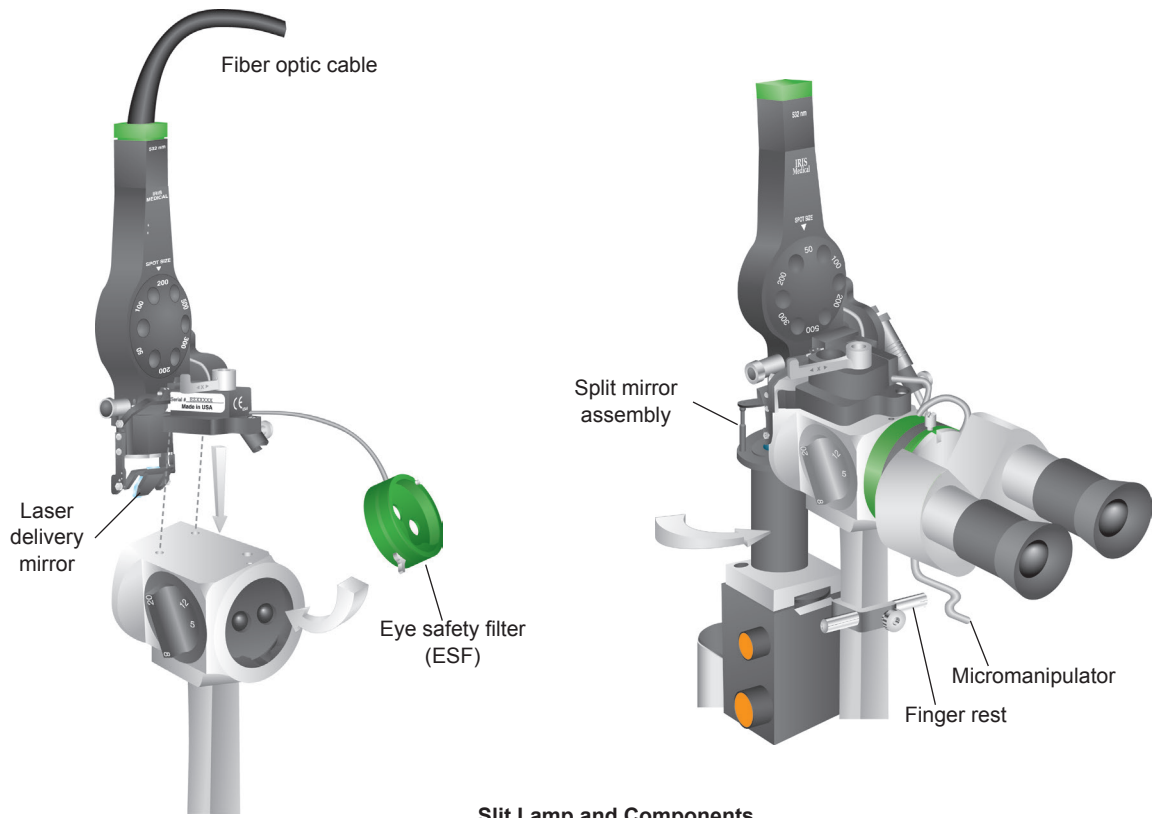

Component	Description
Illumination prism	Projects white light from slit lamp without interference with laser delivery.
Micromanipulator	Allows independent beam steering capabilities.
ESF	Protects against laser wavelength reflected back to oculars.
Finger rest	For use when using the micromanipulator.
Spacer	As necessary, depending on SLA model.
Mounting bracket	As necessary, depending on SLA model.
Slit lamp table	Diagnostic system to which SLA attaches (workstation component).
Slit lamp	Delivered with workstations and Symphony system.
Fiber-optic cable	Transmits laser light.
SmartKey®	Communicates spot size and filter information to the IRIDEX console.

Connecting Consoles

Symphony

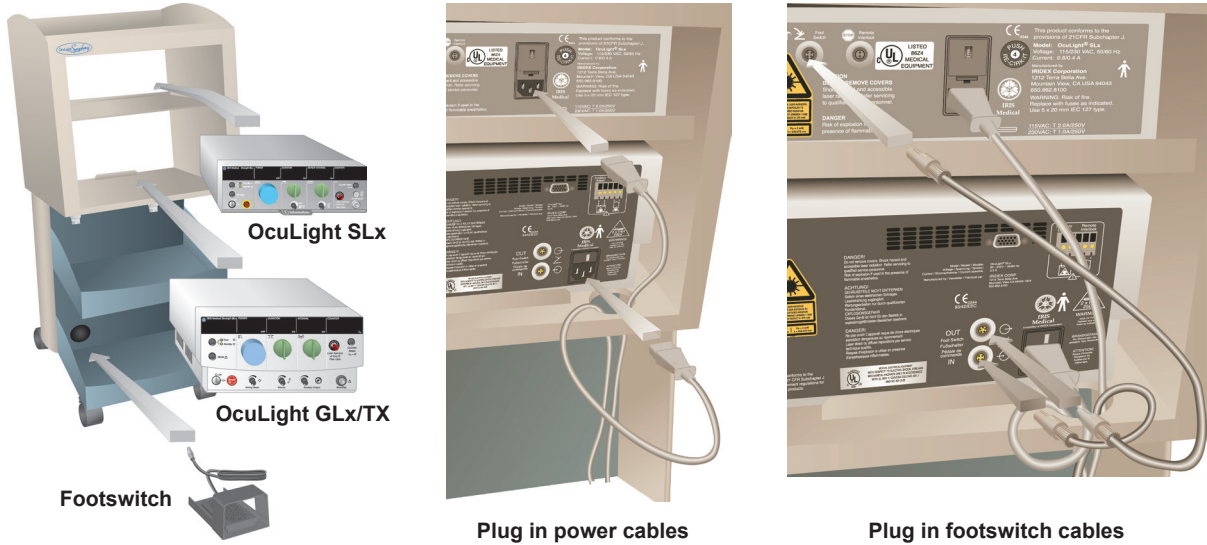

Symphony 2

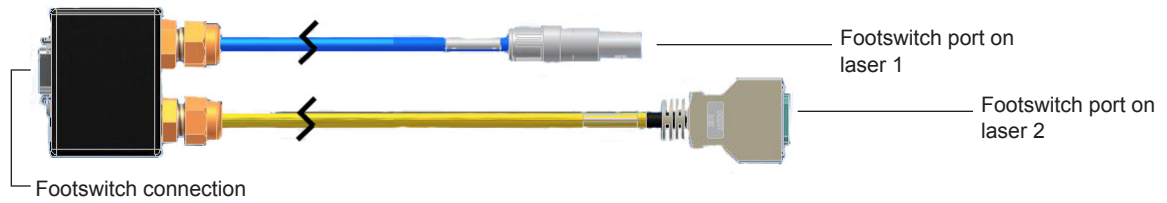

Connector will have compatible connectors specific to laser type.

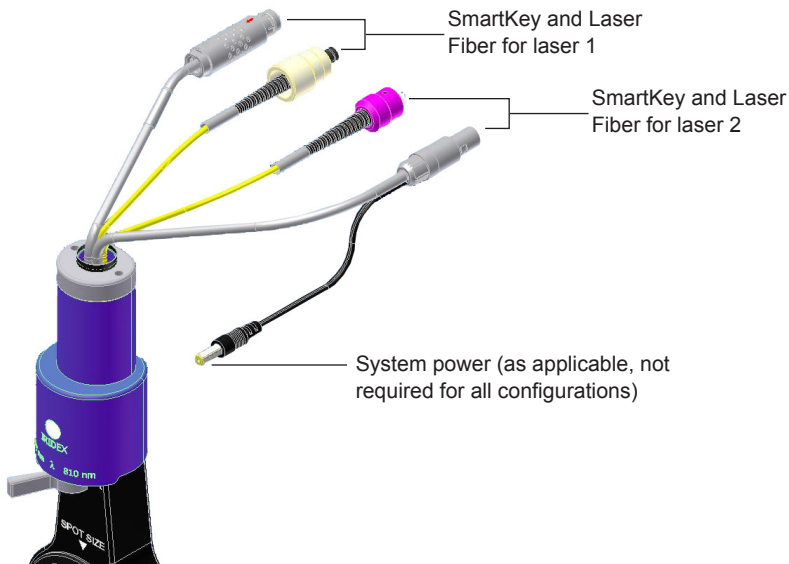

Install SLA on a Slit Lamp

1. Lock slit lamp in place.
2. Move illumination tower out of the way.
3. Install illumination prism as applicable (Zeiss-style slit lamps only).

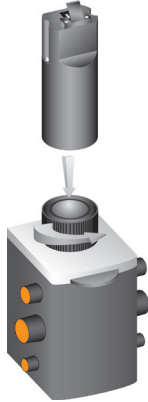

4. Install mounting bracket or spacer as necessary.



5. Unlatch ESF from storage position. Place SLA on the post of the slit lamp microscope. Tighten with thumbscrew.

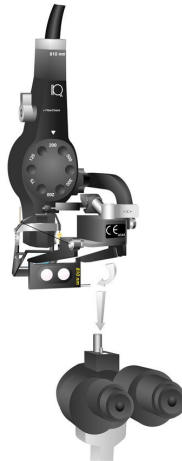

6. Install ESF (as applicable).

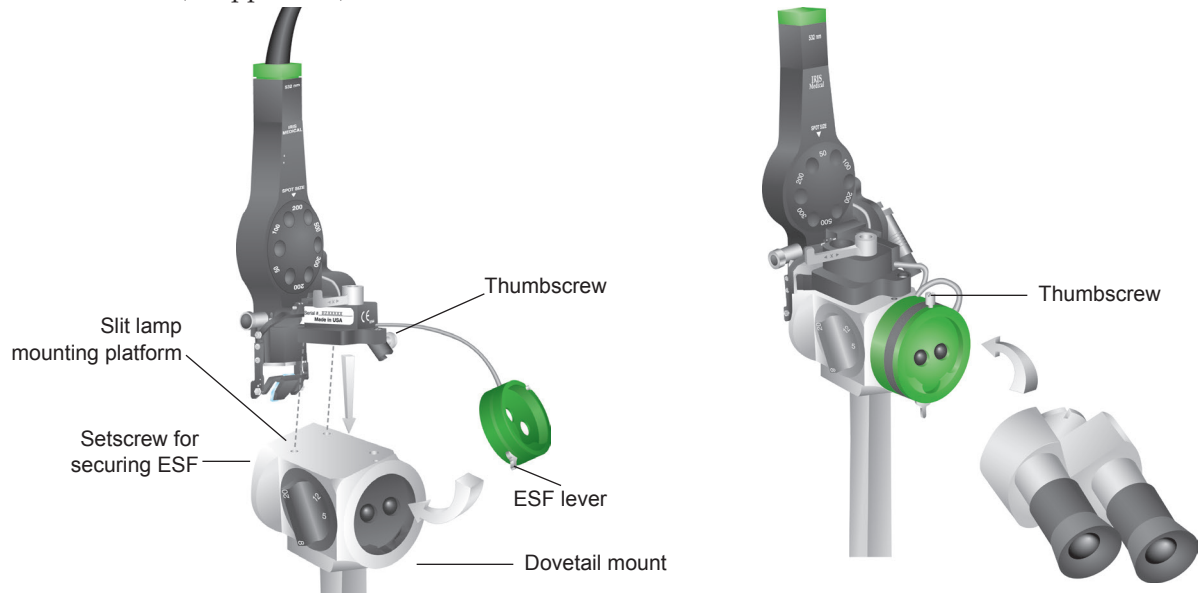

7. Install micromanipulator and finger rest (as applicable). Tighten with thumbscrews.

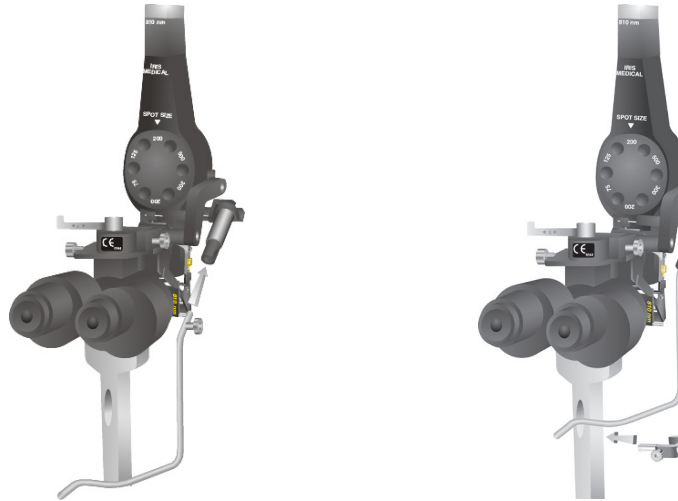

8. Secure fiber-optic cable to slit lamp.

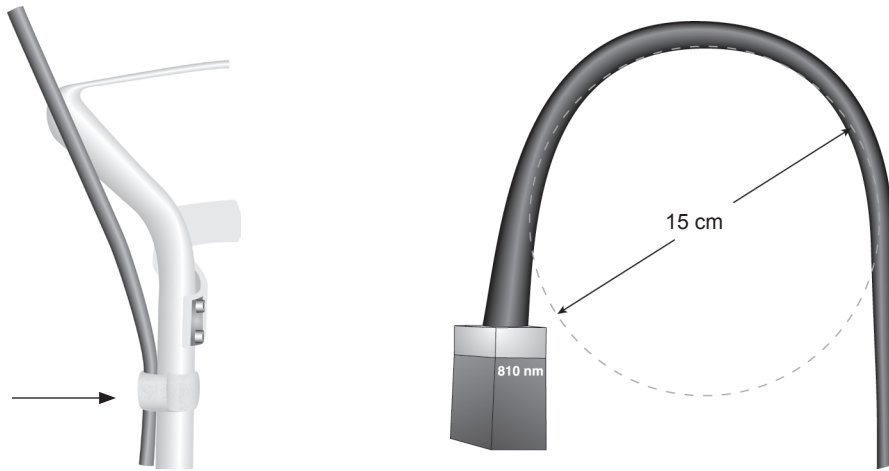

Connect the Fiber Optic and the SmartKey to the Laser Console

NOTE: For Symphony SLA, insert the SmartKey into the console you are using for treatment.

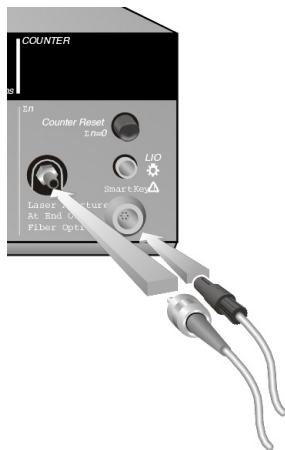

IQ 810

Select the Fiber Optic or wavelength (Symphony / Symphony 2)

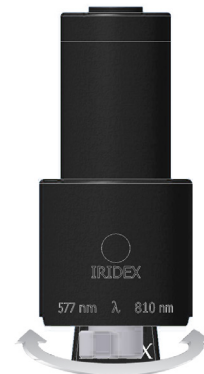

Select the Spot Size



Verify the Focus

1. Turn on IRIDEX laser to see aiming beam.
2. Use X and Y adjustments to center aiming beam in illumination slit.
3. Use Z adjustment or mounting plate for fine focus.

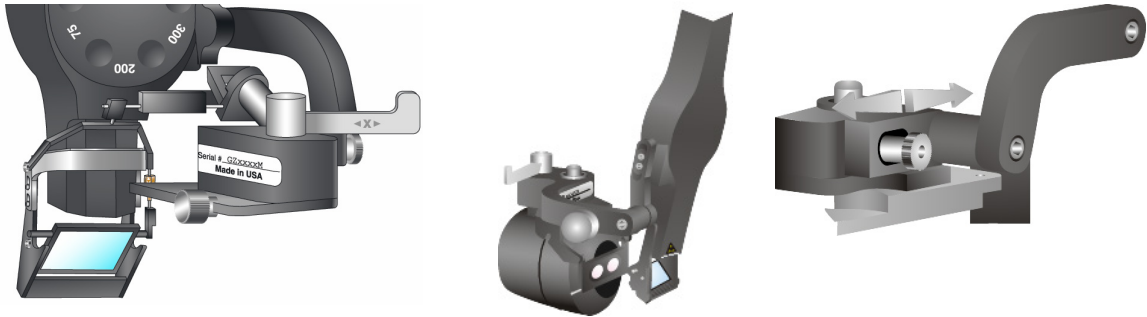

Activate FiberCheck

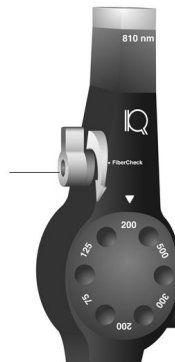

Set the Two-Position ESF

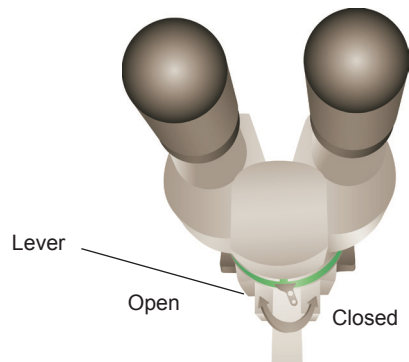

Install Interface Box (SL 130 Integrated Workstation)

1. Secure the interface box to the slit lamp table.
2. Plug the ESF cable into the interface box connector, aligning the pins and the red dot.
3. Connect the interface cable and footswitch cable to the interface box.

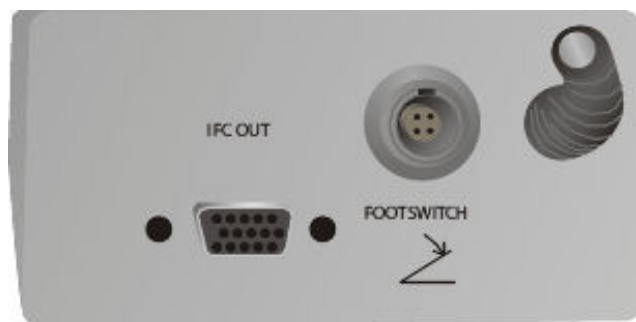
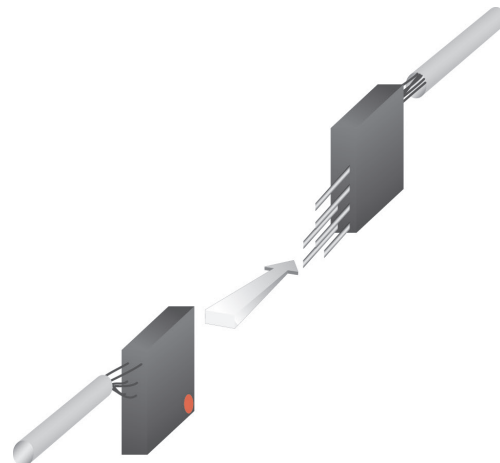
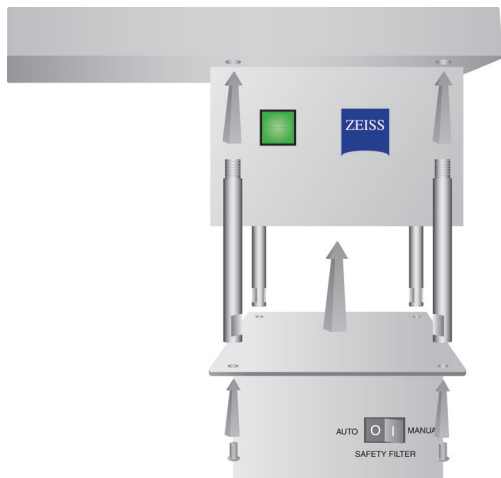

Treating Patients

BEFORE TREATING A PATIENT:

- Ensure that the eye safety filter (as appropriate) is properly installed and that the SmartKey[®], if used, is selected.
- Ensure that the laser components and delivery device(s) are properly connected.
- Post the laser warning sign outside the treatment room door.

***NOTE:** Refer to Chapter 5, "Safety and Compliance," and your delivery device manual(s) for important information about laser safety eyewear and eye safety filters.*

TO TREAT A PATIENT:

1. Turn on the laser.
2. Reset the counter.
3. Set the treatment parameters.
4. Position the patient.
5. If required, select an appropriate contact lens for the treatment.
6. Ensure that all ancillary personnel in the treatment room are wearing the appropriate laser safety eyewear.
7. Select Treat mode.
8. Position the aiming beam on the treatment site.
9. Focus or adjust the delivery device as applicable.
10. Press the footswitch to deliver the treatment beam.

TO CONCLUDE PATIENT TREATMENT:

1. Select Standby mode.
2. Record the number of exposures and any other treatment parameters.
3. Turn off the laser and remove the key.
4. Collect the safety eyewear.
5. Remove the warning sign from the treatment room door.
6. Disconnect the delivery device(s).
7. Disconnect the SmartKey, if used.
8. If the delivery device is single-use, dispose of it properly. Otherwise, inspect and clean the delivery device(s) as instructed in your delivery device manual(s).
9. If a contact lens was used, handle the lens according to the manufacturer's instructions.

3

Troubleshooting

General Problems

Problem	User Action(s)
No display	<ul style="list-style-type: none"> • Verify that the keyswitch is on. • Verify that the components are properly connected. • Verify that the electrical service is on. • Inspect the fuses. <p>If there is still no display, contact your local IRIDEX Technical Support representative.</p>
Inadequate or no aiming beam	<ul style="list-style-type: none"> • Verify that the delivery device is properly connected. • Verify that the console is in Treat mode. • Turn the aiming beam control fully clockwise. • Verify that the fiber-optic connector is not damaged. • If possible, connect another IRIDEX delivery device and place the console in Treat mode. <p>If the aiming beam is still not visible, contact your local IRIDEX Technical Support representative.</p>
No treatment beam	<ul style="list-style-type: none"> • Verify that the remote interlock has not been activated. • Verify that the aiming beam is visible. • Verify that the fiber switch is in the correct position for the laser system and wavelength you are using. • Verify that the eye safety filter is in the closed position. <p>If there is still no treatment beam, contact your local IRIDEX Technical Support representative.</p>
No illumination light (LIO only)	<ul style="list-style-type: none"> • Verify that the illumination connector is connected to the console. • Verify that the special function control is not between detents. • Check the bulb and replace it (if necessary).
Illumination light is too dim (LIO only)	<ul style="list-style-type: none"> • Verify that the special function control is not between detents. • Adjust the console illumination intensity control.
The aiming beam is large or out of focus on the patient's retina (LIO only)	<p>Readjust your working distance between the LIO headset and the examination lens. The aiming beam should be sharply defined and at its smallest diameter when in focus.</p>

Problem	User Action(s)
The treatment lesions are variable or intermittent (LIO only)	<ul style="list-style-type: none"> • The LIO may be slightly out of focus. This decreases power density. Readjust your working distance to obtain the smallest spot size. • A poorly centered laser beam may be clipping on the examination lens or on the patient's iris. Adjust the laser beam in the illumination field. • The laser treatment parameters may be too close to the tissue response threshold for consistent response. Increase the laser power and/or exposure duration, or select a different lens.
Does not fit on the mounting plate (OMA only)	<ul style="list-style-type: none"> • Inspect and clean the mounting plate. • Verify that the mounting plate corresponds to your microscope.
Laser and viewing systems are not focussed at the same point (OMA only)	<ul style="list-style-type: none"> • Verify installation of a 175 mm microscope objective lens on the microscope. • Turn on the aiming beam to determine focus position and adjust as necessary.
View is blocked or partially blocked by OMA (OMA only)	Set magnification to 10X or more.

4

Maintenance

To PROVIDE ROUTINE CARE:

- Do not tightly kink or bend the fiber-optic cable.
- When connected to the console, ensure that the fiber-optic cable is located away from high traffic areas.
- Do not strike the fiber-optic connector against hard surfaces.
- Keep the delivery mirror and eye safety filters free of fingerprints.
- Keep the SLA attached to the slit lamp, unless it needs to be moved to accommodate another delivery device.
- When not in use, cover the SLA to keep the optics free of dust, and store all accessories in suitable storage containers.

Inspecting the SLA

Frequently inspect the SLA for dirt, debris, and damage.

Cleaning the Fiber-Optic Connector

Always inspect the fiber-optic connector for cleanliness prior to use; if needed, clean the connector using a cotton swab moistened with acetone. Inspect the fiber-optic connector using a minimum of 100X magnification to verify cleanliness. Inspect the lanyard for contamination before re-installing it onto the fiber-optic connector.

Cleaning the External Surfaces

Wipe the external surfaces of the SLA (except the optics) with a soft lint-free cloth dampened with a 70/30 Isopropyl Alcohol (IPA) solution.

Cleaning the Delivery Mirror and Eye Safety Filter

TO CLEAN THE DELIVERY MIRROR AND EYE SAFETY FILTERS:

1. Place 2-3 drops of high-grade acetone onto a cotton swab.
2. Wipe the optics gently in one direction with the swab to remove all dust and debris.
3. Repeat as needed with a fresh swab until all dust and debris have been removed from the optical surfaces.

Replacing the Slit Lamp Illumination Lamp

Refer to your slit lamp manual for detailed instructions on replacing the illumination lamp. Always replace with an identical type of bulb.

TO REPLACE THE SLIT LAMP ILLUMINATION BULB:

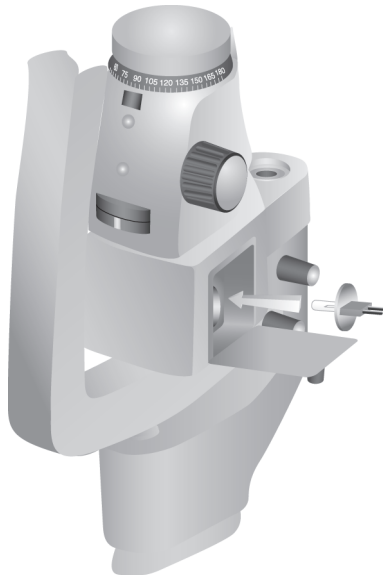

TO CHECK AND CHANGE SLIT LAMP FUSES:

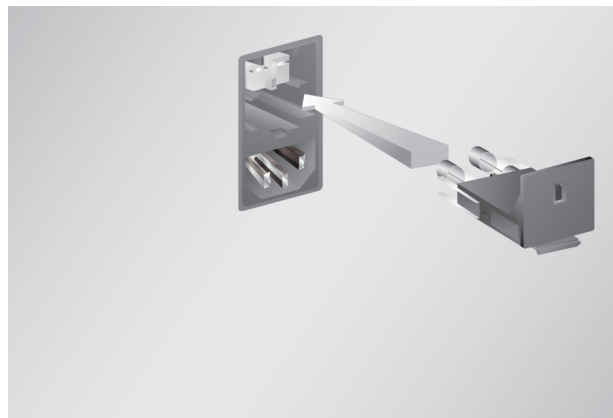

5

Safety and Compliance

To ensure safe operation and prevent hazards and unintended exposure to the laser beams, read and follow these instructions:

- To prevent exposure to laser energy, except as a therapeutic application from either direct or diffusely reflected laser beams, always review and observe the safety precautions outlined in the operator manuals before using the device.
- This device is intended for use only by a qualified physician. The applicability of the equipment and treatment techniques selected is your sole responsibility.
- Do not use any device if you think it is not functioning properly.
- Laser beams reflected from specular surfaces can harm your eyes, the patient's eyes, or others' eyes. Any mirror or metal object that reflects the laser beam can constitute a reflection hazard. Be sure to remove all reflection hazards near the laser. Use non-reflecting instruments whenever possible. Be careful not to direct the laser beam at unintended objects.



CAUTION: *Changes or modifications not expressly approved by the party responsible for compliance could void the user's authority to operate the equipment.*

Protection for the Physician

Eye safety filters protect the physician from backscattered treatment laser light. Integral eye safety filters are permanently installed in every compatible Slit Lamp Adapter (SLA) and Laser Indirect Ophthalmoscope (LIO). For endophotocoagulation or for Operating Microscope Adapter (OMA) use, a separate discrete eye safety filter assembly must be installed into each viewing path of the operating microscope. All eye safety filters have an optical density (OD) at the laser wavelength sufficient to permit long-term viewing of diffuse laser light at Class I levels.

Always wear appropriate laser safety eye wear when performing or observing laser treatments with the unaided eye. Refer to laser console Operator Manual for laser safety eye wear minimum OD, it is specific per each laser console wavelength and maximum power output.

Protection for All Treatment Room Personnel

The Laser Safety Officer should determine the need for safety eyewear based on the Maximum Permissible Exposure (MPE), Nominal Ocular Hazard Area (NOHA), and Nominal Ocular Hazard Distance (NOHD) for each of the delivery devices used with the laser system, as well as the configuration of the treatment room. For additional information, refer to ANSI Z136.1, ANSI Z136.3, or European Standard IEC 60825-1.

Safety Compliance

Complies with FDA performance standards for laser products except for deviations pursuant to Laser Notice No. 50, dated June 24, 2007.

CE-marked devices comply with all requirements of the European Medical Device Directive MDD 93/42/EEC.

Labels

NOTE: The actual label may vary with laser model.

Serial Number

CE Label

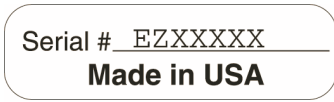

SN 123456789



REF



Rev A

(01)
(11)
(21)123456789

OR

PN 77089 Rev A

Wavelength Label



Laser Aperture, Laser Emission Labels

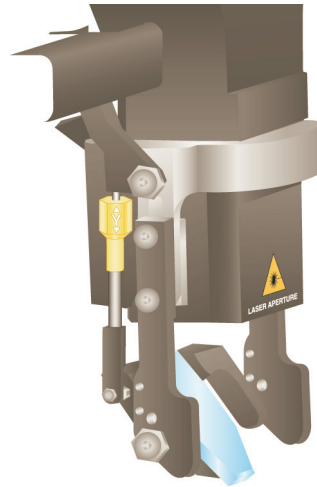

ESF Wavelength Label

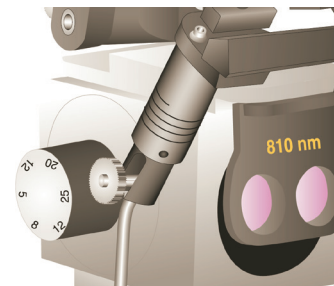

SLA, FiberCheck

Interface Box
(SL 130 Workstation)
Labels

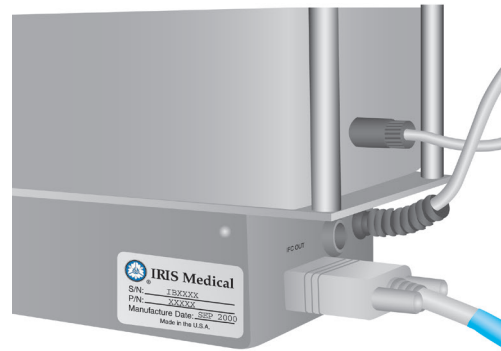
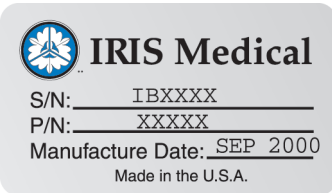



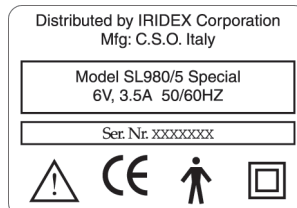

































































Slit Lamp Serial
Number Label



(on back of slit lamp base)

Symbols (As Applicable)

	Aiming Beam		Angle		Aspirating Probe
	Caution		Audible Signal		CE Mark
	Connector Type		Do Not Use if Package is Damaged		Duration
	Duration with MicroPulse		Emergency Stop		ETL Mark
	EtO Sterile		EU Authorized Representative		Expiration Date
	Footswitch		Footswitch In		Footswitch Out
	Fuse		Gauge		Protective Earth (Ground)
	Illuminating Probe		Decrease/Increase		Interval
	Interval with MicroPulse		Laser Aperture at End of Fiber		Laser Warning
	Illumination		LOT		Manufacturer
	Date of manufacture		Off		On
	Part Number		Power		Pulse Count
	Pulse Count Reset		No-ionizing Electromagnetic Radiation		Read Information
	Remote Control		Remote Interlock		Serial Number
	Single Use		Standby		Treat
	Type B Equipment		Waste Electrical and Electronic Equipment (WEEE)		Pattern is Activated

	Temperature Limitations	IPX4	Protections Against Splash Water Coming from all Directions	IPX8	Protections Against Continuous Immersion
	Refer to Instruction Manual/Booklet (in blue)		Initial Power (PowerStep)		Interval between Groups
	Number of Pulses (Group)		Number of Steps (PowerStep)		Power (MicroPulse)
	Power Increment		Power Increment (PowerStep)		Parameter is Locked
	USB		Port Indicators		Laser Firing
	Laser Preparing		Speaker		Screen
	System Brightness		Latex Free		Prescription
	Warning, Replace with fuses as indicated				

SLA Specifications

SLA	Spot Size		Treatment Wavelength
	Standard	Large spot	
Standard	75 - 500 μm	500 - 3000 μm 600 - 5000 μm	810 nm
	75 - 500 μm 50 - 500 μm		532 nm 577 nm
Symphony	125 - 1000 μm	600 - 5000 μm	810 nm
	50 - 500 μm		532 nm
Symphony 2	50 - 500 μm		532 nm / 577 nm
	125 - 1000 μm		810 nm
EasyFit	50 - 500 μm		532 nm / 577 nm
EasyView	50 - 500 μm		532 nm / 577 nm
FiberCheck	75 - 500 μm	600 - 5000 μm	810 nm
Integrated IRIDEX Workstation	50 - 500 μm		532 nm / 577 nm